

# MONTAGEANLEITUNG ASSEMBLY INSTRUCTION

## “Der Roland”

ART.-NR. 500 728



ROLAND WERK GmbH

Industriestraße 16

49681 Garrel

Tel.: 0 44 74 / 94 83-0







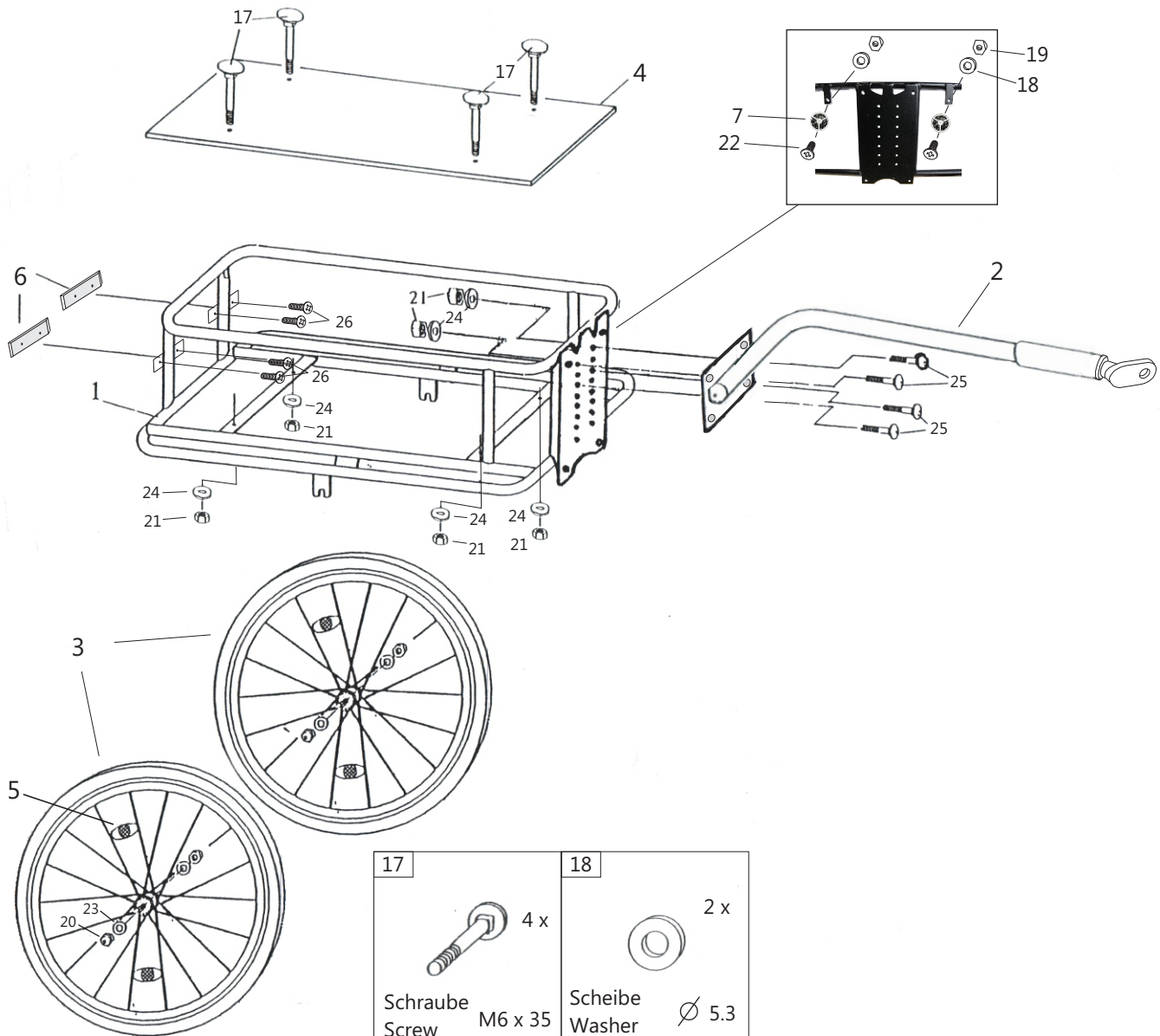

Fax: 0 44 74 / 94 83-33

[www.roland-werk.de](http://www.roland-werk.de)



# MONTAGEANLEITUNG ASSEMBLY INSTRUCTION

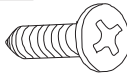
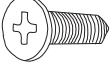

<p>19</p>  2 x <b>Stopmutter</b> Stop Nut M5	<p>20</p>  4 x <b>Achsmutter 7,9 FG</b> (mit 20 N anziehen) Axle nut (fasten with 20 N)	<p>21</p>  8 x <b>Mutter</b> Nut M6	<p>17</p>  4 x <b>Schraube</b> Screw M6 x 35	<p>18</p>  2 x <b>Scheibe</b> Washer $\varnothing$ 5.3
<p>23</p>  8 x <b>Kontaktscheibe</b> contact washer $\varnothing$ 10.2	<p>24</p>  8 x <b>Scheibe</b> Washer $\varnothing$ 6.4	<p>25</p>  4 x <b>Schraube</b> Screw M6 x 16	<p>26</p>  4 x <b>Blechschaube</b> Tapping screw 3,5 x 9,5mm	<p>22</p>  2 x <b>Senkkopfschraube</b> Countersunk bolt 5 x 14mm

Nr. No.	Beschreibung Description	Stck Pcs
1	Rahmen Frame	1
2	Tiefdeichsel Low Tow arm	1
3	Lafräder Wheels	2
4	Bodenplatte Base plate	1
5	Speichenreflektoren Spoke reflectors	4
6	Z-Reflektoren rot Z-Reflectors red	2
7	Reflektoren weiß Reflectors white	2